

TELETYPE  
model 28 THE  
LEADERSHIP  
LINE

# SEND-RECEIVE and RECEIVE-ONLY PAGE PRINTER SETS

## GENERAL DESCRIPTION

The Model 28 *Page Printer Sets* are designed for use as data transmission terminals in either cross office or cross country record communications. The Send-Receive model provides maximum flexibility for applications requiring both transmission and reception facilities. The Receive-Only model is identical except that it does not have the mechanisms for generating the five level Start-Stop signal.

The *Page Printer Sets* require two external connections: a power lead to a conventional, 110 volt, AC or DC source; and a signal line to interconnect associated equipment. Signal line battery may be obtained from either a remote or internal DC supply. The Typing Unit requires a neutral signal in sequential form, but provision may be made for the acceptance of either polarized or parallel input.

Although a Set's components are available for separate, system installation, they are normally assembled in either a floor or table model console. For rack mounting a special, close-fitting cover is furnished. A wide variety of optional accessories permit the tailoring of each set for specific application requirements. These accessories may be factory installed or furnished separately.

Table Model Console  
with Receive-Only Base



Table Model Console  
with Send-Receive Keyboard



Rack Mounted Cover  
with Send-Receive Keyboard





Floor Model Console  
with Receive-Only Base



Floor Model Console  
with Send-Receive Keyboard

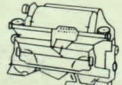

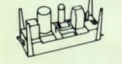
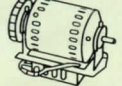
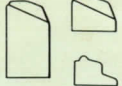
A SET CONSISTS OF:	A TYPICAL COMPONENT DESIGNATION IS:	THE DESIGNATION INDICATES:
Typing Unit 	L P 29 RA / AR	Model 28 Printer Model Number Typebox Arrangement Stunt Box Arrangement (Model Number includes accessories)
Transmitting Keyboard 	L K 11 ARA	Model 28 Keyboard Model Number Keypop Arrangement (Model Number includes accessories)
OR Receive Only Base 	L B 4 / 146	Model 28 Base Model Number Accessory Group (Model Number will later incorporate accessories)
Electrical Service Unit 	L ESU 7 / 152	Model 28 Electrical Service Unit Model Number Accessory Group
Motor 	L MU 3	Model 28 Motor Unit Model Number
Consoles 	L AC 204 AB 222 (PC)	Model 28 Apparatus Cabinet (Floor—Table) (Printer Cover) (Rack Mount) Model Number Color Accessory Group

## COMPONENT WEIGHTS

Typing Unit	20 lbs.
Motor Unit (Synchronous)	8 lbs.
Electrical Service Unit	6 lbs.
Send-Receive Keyboard	14 lbs.
Receive-Only Base	9 lbs.
Floor Console	85 lbs.
Table Console	45 lbs.
Rack Mounted Cover	28 lbs.

## SHIPPING WEIGHTS

	Floor Model Set	Table Model Set	Rack Mounted Set
Domestic Packing	182 lbs.	142 lbs.	125 lbs.
Commercial Export Packing	331 lbs.	250 lbs.	250 lbs.

## INDEX

	Page		Page
Base Unit	2	Multi-wire Distributor	8
Consoles	6	Stunt Box	4 5
Electrical Service Unit	7	Timing Diagram	6
Keyboard	2	Typing Unit	3
Motors	7	Wiring Diagram	8

## SEND-RECEIVE KEYBOARD (LK) & RECEIVE-ONLY BASE (LB)

Both the *Send-Receive Keyboard* and *Receive-Only Base* provide mounting facilities for the typing unit, motor, gear bracket and the mechanisms required for local control of the page printer set. Only the *Send-Receive Keyboard* is equipped with the parts necessary for the generation and transmission of a conventional, five level, start-stop signal.

The *Send-Receive Keyboard* or *Receive-Only Base* is attached to a shock mounted cradle assembly in the floor and table model consoles. In the rack mounted set the *Send-Receive Keyboard* is attached to a base plate which is clamped to the printer cover. Design of the cover does not permit use of the *Receive-Only Base*.

Signal and control leads terminate at a 21-point Connector; power leads, from the motor, connect to a 4-point terminal board. Both plug and terminal board are located at the rear of the units.

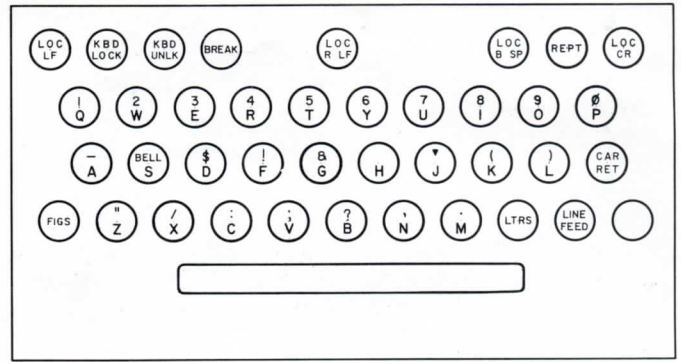

Typical Key Arrangement

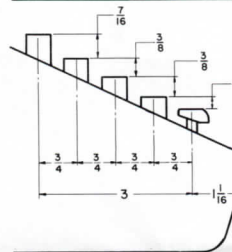

Key dimensions

### COMPARISON CHART

	SEND-RECEIVE KEYBOARD	RECEIVE-ONLY BASE	NOTES
<b>I KEYS</b>			
Local Control Keys	Space provided for 11. Keys are red with white characters.	Space provided for 3. Keys are grey-green with white characters.	Standard and optional local controls are listed below.
Transmission Keys	32 including Space Bar. Keys are grey-green with white characters.	none	Upper case symbols may be selected to meet application requirements.
<b>II ACCESSORIES</b>			
Operator's Instruction Panels	Standard—2 panels 2" X 4 1/2"	Standard—2 panels 1 1/4" X 2 1/2"	Black paper, white carbon and plastic covers included.
Margin Indicator Lamp Contact	Standard	Optional	Operating point is adjustable.
Electrical Noise Suppression	Optional	—	RF Filter connected across signal generator contacts.
Motor Control Time Delay Mechanism	Optional	Optional	Responds to extended period of idle signal line time. Chars./Min. Idle Time Required 600 53 - 106 sec. 460 69 - 138 sec. 368 86 - 173 sec.
<b>III LOCAL CONTROLS</b>			
Local Carriage Return	Standard	Standard	No signal transmitted.
Local Line Feed	Standard	Standard	No signal transmitted.
Keyboard Lock/Unlock (Mechanical)	Standard	—	Mechanical block on keys. May also be operated on-line, through stunt box.
Keyboard Lock/Unlock (Electrical)	Optional	—	Electrical shunting of signal generator. May also be operated on-line through stunt box.
Repeat	Standard	—	Continuous character transmission.
Signal Line Break	Standard	Optional	Mechanical Break parts for Keyboard only. Electrical Break for Keyboard or Base.
Line Feed/Motor Start	Optional	Optional	Modification Kit includes motor control parts but not line feed parts.
Local Backspace	Optional	—	May also be operated on-line, through stunt box.
Local Reverse Line Feed	Optional	—	May also be operated on-line, through stunt box.
Repeat Space	Optional	—	Continuous Space transmission while Space Bar is depressed.
Print/Non-Print Switch	—	Optional	For local control of selective calling typing units.
Local Transmitter Control	—	Optional	Employs Margin Indicator Lamp Contact. Requires Automatic CR/LF parts.

Set with Send-Receive Keyboard (Shown tilted for inspection)

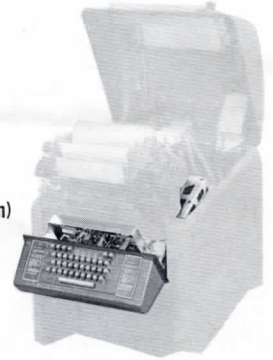

Set with Receive-Only Base (Shown tilted for inspection)

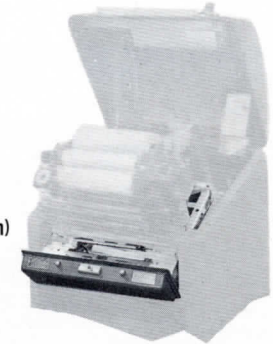

Send-Receive Keyboard — Top view

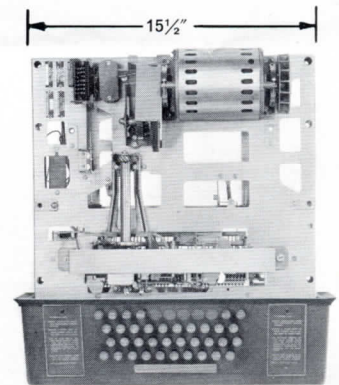

Send-Receive Keyboard — Side view

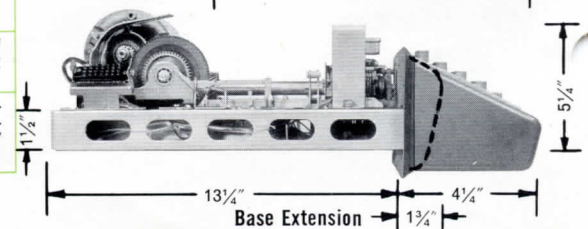

**TYPING UNIT (LP)**

The *Typing Unit* contains the mechanisms necessary for translating electrical input signals into printed, alpha-numeric characters or functional control operations ranging from internal print suppression to supervisory control of external equipment. The unit will accommodate friction or sprocket fed paper, in single or multi-copy form, either rolled or fanfolded. Typebox or individual pallet substitution is a simple operation requiring little time and no re-adjustment.

The *Typing Unit* is mounted on either the Send-Receive Keyboard or Receive-Only Base and positioned on the locating studs provided. The motor power is coupled through pinion and driving gears to the *Typing Unit's* main shaft. All electrical connections terminate at a 21-point Connector located on the right side frame. An additional plug is available if required.

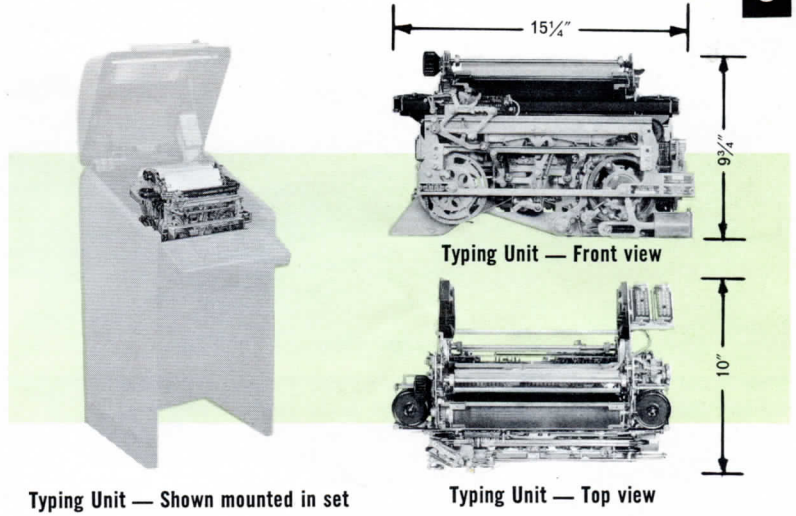

Typing Unit — Shown mounted in set

Typing Unit — Top view

**TYPE PALLET ARRANGEMENTS**

Standard, upper case pallet arrangements are:

- Communications (Punctuation symbols)
- Fractions
- Weather Symbols

Individual pallets, for upper and lower case characters, may be ordered separately for field installation.

**TYPING UNIT RIBBON**

- Style.....Black record ribbon—  
Underwood spool
- Length.....33'
- Width.....1/2"
- Thickness......0055"
- Reversing eyelet thickness... .060" min.
- Reversing eyelet location.... Min. 4" between eyelet and spool hook

**TYPING UNIT PAPER**

The dimensions of the standard, yellow paper roll, used by many customers on friction feed typing units, are:

- Outside diameter..... 4 1/2"
- Width..... 8.453" ± .031"
- Length..... 325'
- Core diameter..... 1"
- Core thickness..... .125"

**TYPE STYLES AND SPACING**

Style	Character Height		Horizontal Characters Per Inch		Vertical Lines Per Inch <sup>b</sup>		Actual Type Sample
	Caps	Fraction	Single - SPACE - Double <sup>a</sup>		Single - FEED - Double		
Murray	.103"	.162"	10	5	6	3	ABCDEFGHIJKLMNOP12345
Gothic	.103"	none	10	5	6	3	ABCDEFGHIJKLMNOP12345
Gothic	.103"	.162"	12 <sup>a</sup>	6	6	3	ABCDEFGHIJKLMNOP123456789
Long Gothic	.120"	.170"	d	5	6	3	ABCDEFGHIJKLMNOP12345
Large Gothic	.180"	.180"	d	5	c	3	ABCDEFGHIJKLMNOP12345

Notes:

- a Require special parts which may be ordered separately
- b Special parts also available for triple line feed and four lines-per-inch
- c Not recommended for single Line Feed
- d Not recommended for 10 characters per inch

**PLATENS**

	FRICITION FEED	SPROCKET FEED
Construction	Rubber covered cylinder, fixed to platen shaft.	Rubber covered cylinder, free on platen shaft.
Length	8 3/4"	Selected for desired form width. (See Below Right)
Paper Width	Any width up to 8 1/2"	Minimum: 3 3/8" Maximum: 9" (See Below Right)
Characters per line (10 per inch)	Margin is adjustable from 1 to 85 characters	Margin is adjustable from 1 to maximum number indicated in chart.

**AVAILABLE ACCESSORIES**

Accessory	Notes											
Horizontal Tabulation	Available with or without transmitter control parts.											
Form Feed Out	Available with or without transmitter control parts. May be used on the following form lengths (in inches):											
	<table border="0"> <tr> <td><b>Friction Fed</b></td> <td><b>Sprocket Fed</b></td> </tr> <tr> <td>5 1/2, 11</td> <td>2, 4, 8    5 1/2, 11</td> </tr> <tr> <td></td> <td>4 1/4, 8 1/2    3, 6, 12</td> </tr> <tr> <td></td> <td>4 1/2, 9    6 1/2, 13</td> </tr> <tr> <td></td> <td>9 1/2    3 1/2, 7, 14</td> </tr> <tr> <td></td> <td>5, 10    7 1/2, 15</td> </tr> </table>	<b>Friction Fed</b>	<b>Sprocket Fed</b>	5 1/2, 11	2, 4, 8    5 1/2, 11		4 1/4, 8 1/2    3, 6, 12		4 1/2, 9    6 1/2, 13		9 1/2    3 1/2, 7, 14	
<b>Friction Fed</b>	<b>Sprocket Fed</b>											
5 1/2, 11	2, 4, 8    5 1/2, 11											
	4 1/4, 8 1/2    3, 6, 12											
	4 1/2, 9    6 1/2, 13											
	9 1/2    3 1/2, 7, 14											
	5, 10    7 1/2, 15											
Automatic Carriage Return/Line Feed	Cannot be used on certain selective calling units.											
Auxiliary Connector	An additional Connector — installed next to present one.											
Paper Spindle Latches	To secure paper roll spindle and permit operation in any plane.											
Extension Rods	Permits standing unit on either end for maintenance.											

NOTE: Certain accessories listed on page 2 (Keyboard) also apply to and require parts for the TYPING UNIT.

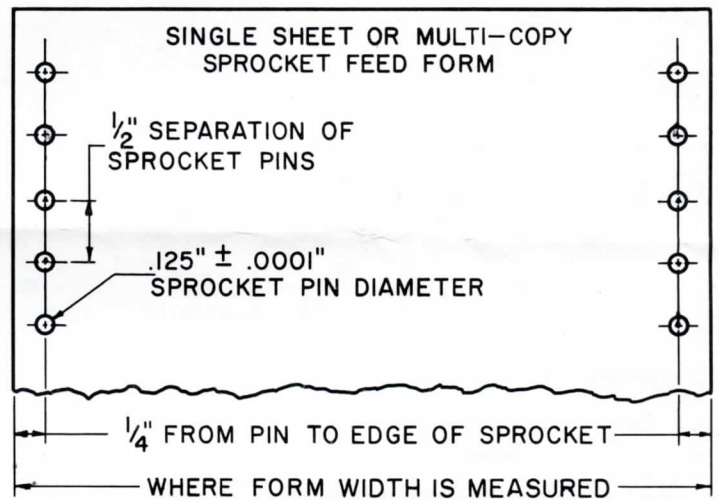

**AVAILABLE SPROCKET FEED PLATENS**

FORM WIDTH IN INCHES	MAXIMUM CHARACTERS <sup>a</sup> PER LINE	FORM WIDTH IN INCHES	MAXIMUM CHARACTERS <sup>a</sup> PER LINE
9	80	5 3/4	47
8 1/2	75	5 1/2	45
8	70	5	40
7 1/2	65	4 1/2	35
7	60	4 1/4	33
6 1/2	55	4 1/8	32
6 3/8	54	4	30
6 1/4	53	3 3/8	26
6	50		

NOTE: a—On a basis of ten characters per inch.

**STUNT BOX**

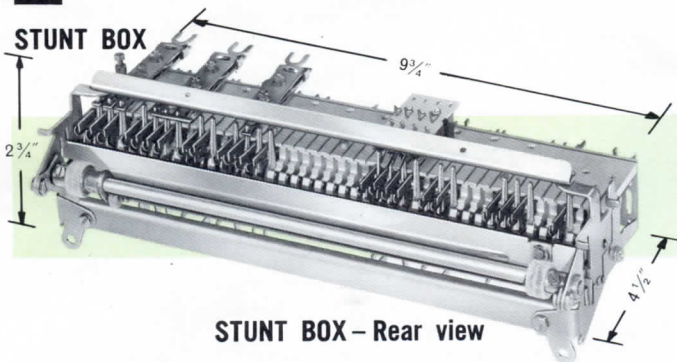

**STUNT BOX - Rear view**

The *Stunt Box* is installed in the rear of the Typing Unit and driven from a clutch assembly on the main shaft. Forty-two functional control positions are provided. Less than half of these are reserved for specific functions, the remainder may be arbitrarily allocated for desired operations.

Individual function mechanisms may be selected by a single character or upon the receipt of a sequence of characters. The mechanisms may be used to control the Page Printer Set and coordinate the operation of remote equipment.

Over one hundred *Stunt Box* arrangements are available as complete assemblies.

**FUNCTION BARS**

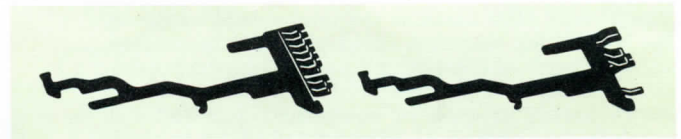

**153440** — Uncoded ('Universal') function bar

Typical, pre-coded function bar for specific character or condition

**FUNCTION PAWLS**



**152653** — To operate associated lever only



**153598** — Special pawl used in slot adjacent to slot with 153604 pawl



**153604** — To operate associated lever plus lever in adjacent, higher numbered, slot

**FUNCTION LEVER COMPARISON CHART**

Function Lever Extension Purpose	PART NUMBER	152121	152298	152299	152641	152642	152659	153670	154646	154647	155736	155737	157205	157206	157207
A. Used with 155738 Blocking Rod to prevent operation of eight other function levers.															
B. Will operate contacts in two, adjacent slots simultaneously.															
C. Will operate shift slide OR contact.		•	•	•	•	•	•	•	•	•	•	•			
D. Will block associated function bar.									•						
E. Will block function bar in adjacent, higher numbered slot.		•					•								•
F. May be latched in operated position.		•	•				•	•	•		•	•	•	•	•
G. May operate a slide.		•	•		•	•	•				•	•		•	•
H. Will Suppress Spacing.				•	•		•		•	•	•				
I. May be operated by a releasing rod.									•						
J. May operate a releasing rod.				•				•	•				•		

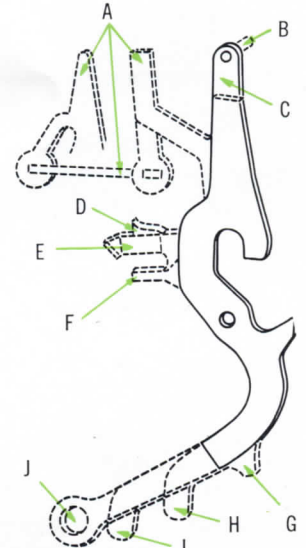

**Composite Function Lever**

**LATCH RELEASE BAILS AND STUDS**

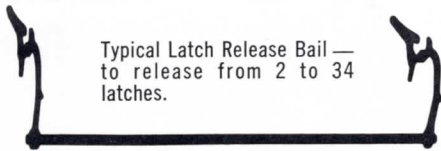

Typical Latch Release Bail — to release from 2 to 34 latches.



**152357 Stud** — to release latch in adjacent, higher numbered, slot



**157203 Stud** — to release latches in adjacent, higher and lower numbered, slots

**SPRING PLATE AND LATCHES**



**152660 Spring Plate** — Function operates for one cycle only

**154613 Latch** — Function lever remains operated until earliest, succeeding cycle

**152089 Latch** — Function lever remains operated until released by a specific character

**SHIFT FORKS AND SLIDES**



**Standard shift fork assembly** using 153608 fork

**Special 158301 fork** for spring loading

**Special 153596 fork** for spring loading

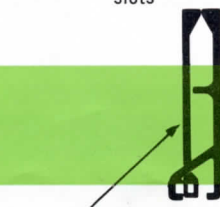

**153795 Slide** — Used for operating shift fork with one function lever

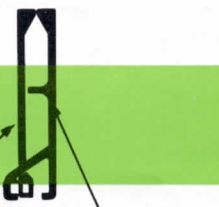

**153643 Slide** — Spans the 153795 slide — May be operated by one or two function levers



**157164 Slide** — Used for operating shift fork by one or two, adjacent function levers



**154639 Slide** — Used for operating shift fork by one to four, adjacent function levers



**155767 Slide** — Used for operating shift fork by one to six, adjacent function levers

**SWITCH ASSEMBLY**

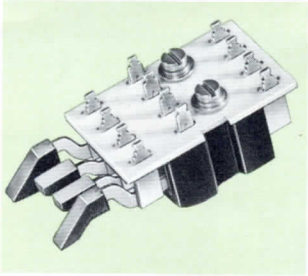

**STUNT BOX CONTACTS**

Construction..... Plastic blocks with slots for a maximum of four sets of contacts. A total of 36 positions are available in this unit for flexibility. Maximum recommended contacts—10.

Maximum recommended contact current—115 v at 100 ma.

**AVAILABLE CONTACTS**

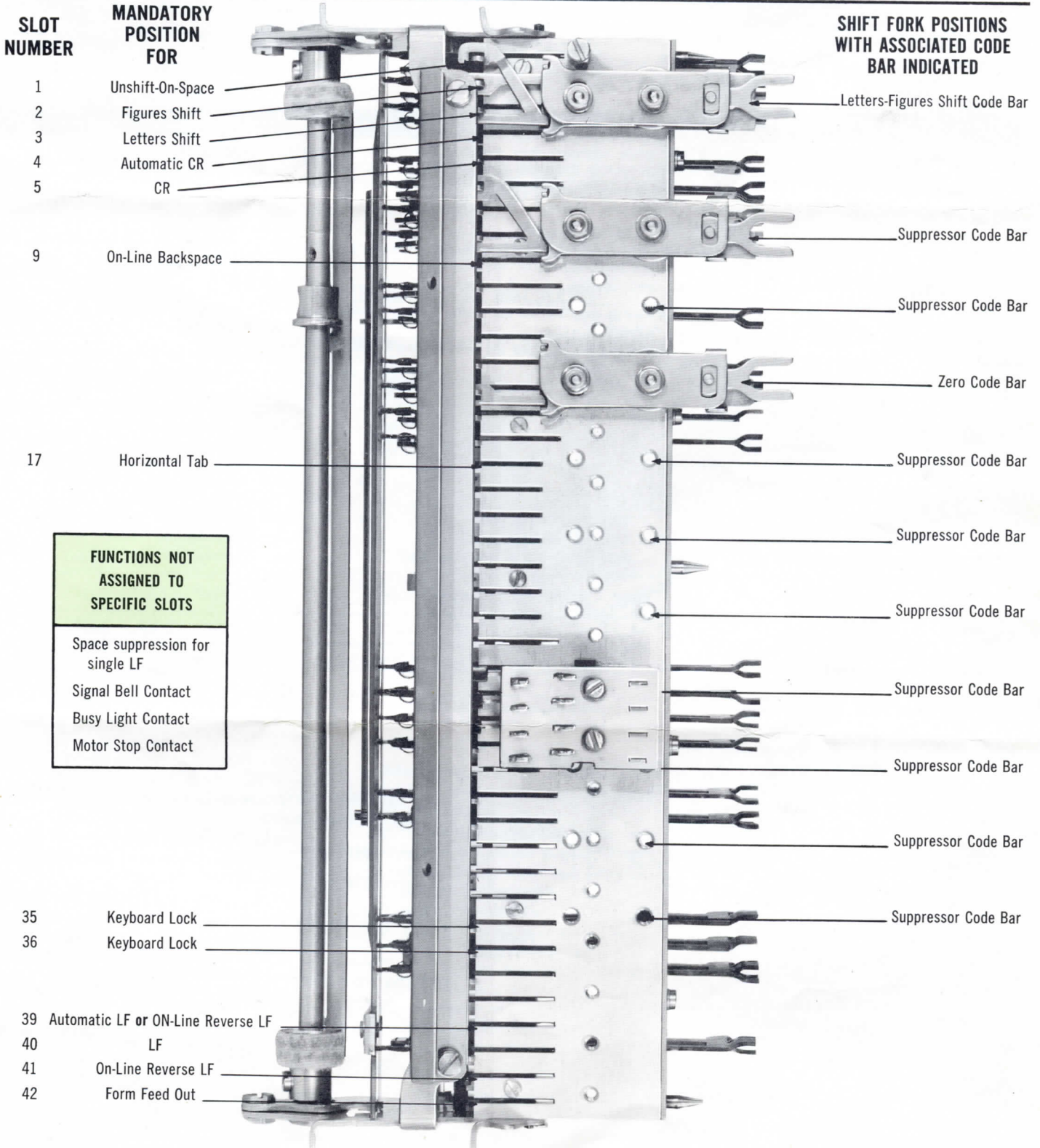
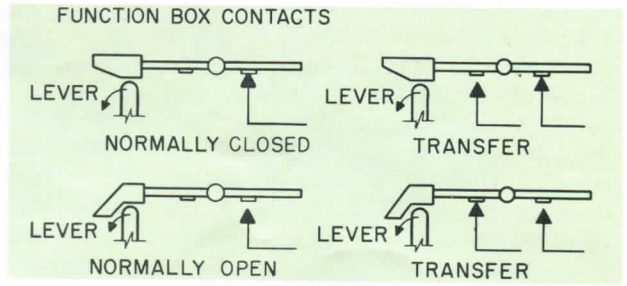

**FUNCTIONS NOT ASSIGNED TO SPECIFIC SLOTS**

- Space suppression for single LF
- Signal Bell Contact
- Busy Light Contact
- Motor Stop Contact

### CONSOLES (LAC & LPC)

The components of the Model 28 Page Printer Set may be installed in one of three consoles: The Floor Model, the Table Model or a special, close-fitting cover. Power and signal lines are routed through openings in the rear of the consoles. In the rack mounted set the lines are connected to terminals in the Electrical Service Unit. In the Floor or Table model the lines are connected either to RF filters, if used, or directly to the terminal boards on the rear wall of the console.

#### CONSOLE FINISHES

Color	Type	Code
Black	Wrinkle	AA
Grey-Green	Wrinkle	AB
Dark Brown	Wrinkle	AD
Federal Grey	Wrinkle	AF
Black, High Gloss	Smooth	BA
Black, Semi Gloss	Smooth	BB
Light Grey	Smooth	BH
Federal Grey	Smooth	BV

Special custom colors also available

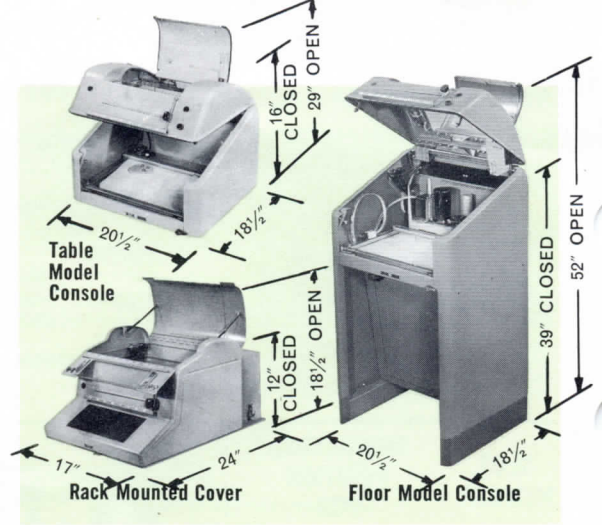

### STANDARD FEATURES

Feature	Floor Model	Table Model	Rack Mounted
Copy Lamps	Two 6.3VAC lamps operating from a 5.5VAC transformer secondary. Located inside (center) of dome. Three position switch permits operation: (1) Continuously on (2) When motor is running or (3) Off		
Copy Tray	Equipped with a movable copy holder and line guide. Mounted on front of dome or cover.		
Signal Bell	Mounted on underside of console floor. Electrically connected to console terminal board.		Mounted on Electrical Service Unit.
Power Switch	On Electrical Service Unit. Operated by extension arm from front of console.		Available through access panel on cover.
Margin Indicator Lamp	One 6.3VAC lamp. Located inside the dome — right side.		One 6.3VAC lamp. Located inside cover — left side.
Terminal Boards	Two terminal boards mounted on rear wall. Twenty terminals on each. Extra boards optional.		All connections made to Electrical Service Unit.
Cradle	Floor of console. May mount either the Send-Receive Keyboard or Receive-only Base.		Keyboard attached to base plate.
Tilting Brackets	Sides of console. Permit tilting of Keyboard (or Base) and Typing Unit for inspection.		Cover removable from base plate for inspection.
Storage Space	Behind lower panel. Panel cover may also be used as maintenance tray.	none	none
Leveling Feet	Bottom of console.	none	none

### CONSOLE ACCESSORIES

Directory Holder Offset Copyholder Apparatus Mounting Rack	Busy Line Indicator Lamp Form Out Alarm Paper Supply and Accumulating Shelf	Paper Winder Mounting Bracket Shock Mounts Sprocket Feed Paper Guide
--	---	--

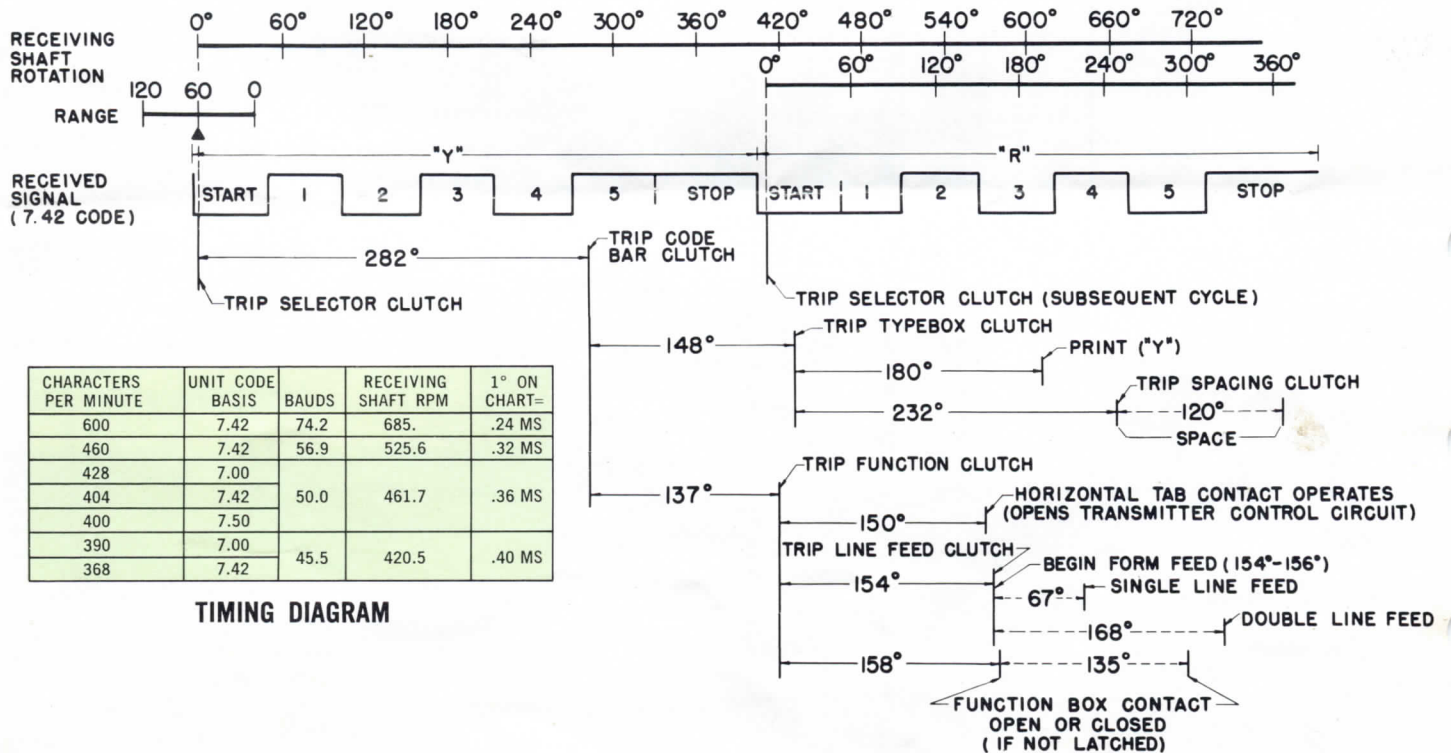

### MOTORS (LMU)

### MOTORS AVAILABLE

Characteristic	Synchronous Motor	AC/DC Series Governed Motor
Speed (RPM)	3600	3600
Horsepower	1/20th	1/20th
Voltage	115VAC ± 10%	115VAC ± 10% <sup>a</sup>
Start Current (AMPS)	9	1.75
Run Current (AMPS)	1.85	1
Frequency (Cycles/Second)	60 ± .75%, single phase	50-60, single phase
Power Consumption (Watts)	65	95
Power Factor	.30	.83
Heat Dissipation (Watts)	50	75
Rotation	CCW from fan end	CCW from governor end
Additional Features	Thermal overload cutout	Adjustable governor

Note: a—Governed motor will also operate on 115VDC, with external resistance.

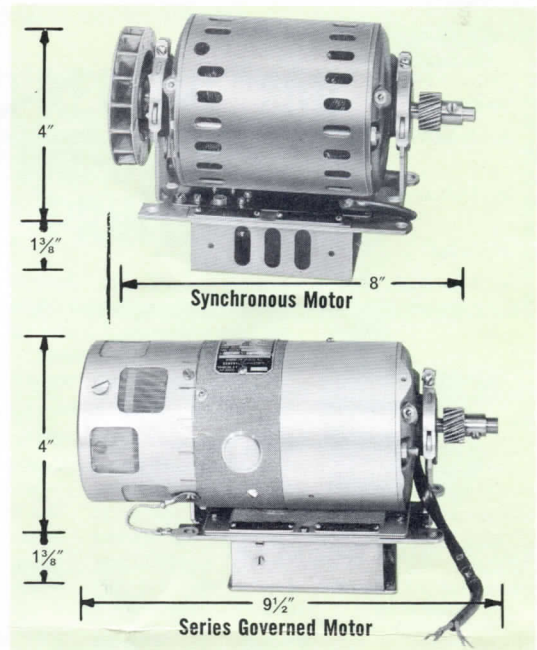

### ELECTRICAL SERVICE UNIT (LESU)

The *Electrical Service Unit* serves as the concentration point for the Page Printer Set's electrical connections. In addition to the line fuse and convenience receptacle, the *Electrical Service Unit* provides terminal boards and mounting facilities for optional sub-assemblies.

The unit is installed, in the Floor and Table model consoles, behind the Keyboard or Base. In the Rack Mounted Set, the *Electrical Service Unit* occupies a separate compartment.

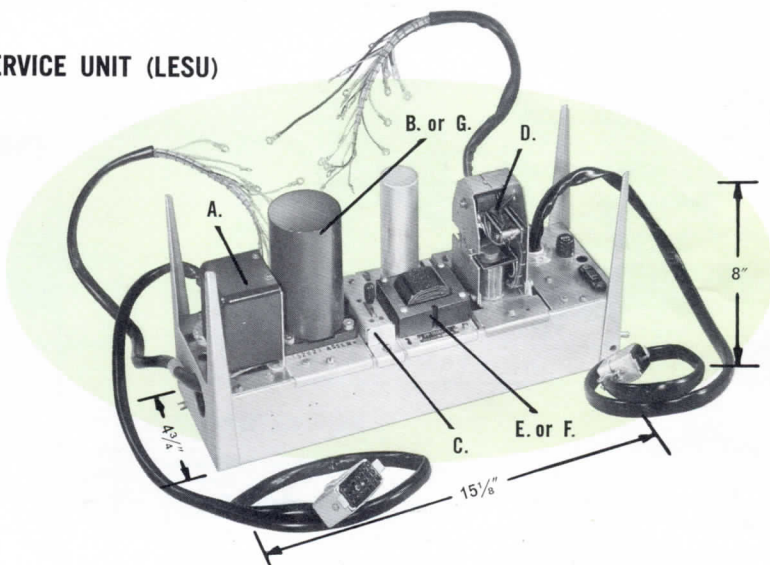

### COMPONENTS AVAILABLE TO MOUNT ON ELECTRICAL SERVICE UNIT (LESU)

- A. Line Shunt Relay:** The signal line is coupled, through the contacts of this relay, either to the Line Relay or directly to the typing unit's selector magnets. When motor power is removed, the relay de-energizes and maintains signal line continuity while bypassing the local unit.
- B. Line Relay:** Utilized to reduce the effects of line distortion or to convert a polar signal to the neutral form required by the typing unit's selector magnets. The relay has two windings: One operated by the signal line and the other by a local DC source. If a polar signal is applied, only the main winding is used. In either case, movement of the armature applies local DC to the selector magnets in response to a MARKING signal line condition.
- C. Line - Test Key:** Permits shunting of the signal line for independent operation of the set. The assembly may be wired to draw either 20MA or 60MA from the local DC

source. An additional set of contacts is included that may be utilized to provide audible or visual indications.

- D. Motor Control:** To provide simultaneous control of all motors in a circuit. Two assemblies are available:
  - (a) Electromechanical: Stops motor when function box contact is closed (Usually on FIGS-"H"), or when a time delay mechanism on the keyboard or base responds to an idle line condition.
  - (b) Solenoid: (Can not be used on DC motors without adequate spark protection).
    - (1) In separate loop: All motors stop when Loop is operated (Battery either applied or removed).
    - (2) In signal line: All motors stop when signal line current is reversed.
- E. Rectifier:** Two rectifier assemblies are available. One is rated at 120MA, the other at 300MA. Both assemblies provide 120VDC

from an input of 115VAC (± 5 volts), 50 to 60 c/s. The output of the rectifier is normally utilized in local circuits such as the typing unit's selector magnets, the Line Relay's bias winding and the Line Test Key Assembly. For use within the set, the 120MA rectifier is usually adequate. The 300MA assembly is offered for special applications where supply of external equipment is desired.

- F. DC Conversion:** A capacitor-resistor assembly to permit operation of such local components as the series governed motor or the Line Test Key Assembly from a direct, DC source. The assembly would be installed in the position normally occupied by the rectifier.
- G. Signal Line Limiting Resistance:** Either a fixed or variable resistance to limit the signal line to the requisite 20MA or 60MA. The variable resistance (rheostat) would be installed in the position normally occupied by the Line Relay.

**INPUT SIGNAL SPECIFICATIONS**

1. *Sequential* (5 intelligence levels with Start and Stop pulses)
  - a. Neutral: Selector magnets may be directly connected to the signal line.
  - b. Polar: Line Relay is mandatory.

2. *Parallel*

- a. Neutral: An accessory multi-wire distributor unit (LD) converts a parallel wire input to the sequential form required by the selector magnets. The distributor has seven contacts:

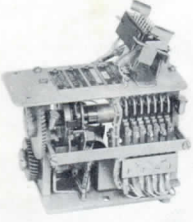

- Five—Intelligence Levels
- One—START—STOP
- One—Control (Aux.)

**SELECTOR MAGNET SPECIFICATIONS**

Connection to Signal Line or Line Relay	Resistance	Inductance <sup>a</sup>	Recommended Current
Series	264 ohms	6 Henrys	30 MA
Parallel	66 ohms	1.5 Henrys	60 MA

<sup>a</sup> Approximate values — Measured on a DC basis with magnet unattracted

**SPEED DATA**

Characters or Operations	Per-Minute	600	460	428	404	400	390	368
	Per-Second	10.0	7.7	7.1	6.7	6.7	6.5	6.1
Unit Code		7.42	7.42	7.00	7.42	7.50	7.00	7.42
Bauds (Bits-per-second)		74.2	56.9		50.0		45.5	
Frequency (Cycles/Second)		37.1	28.4		25.0		22.8	
Length in Milliseconds	One Character	100	130	140	149	150	154	163
	Unit Pulse	13.5	17.6	20.0	20.0	20.0	22.0	22.0
	Stop Pulse	19.1	24.9	20.0	28.5	30.0	22.0	31.2

**AVAILABLE GEARS**

Operations (Characters) Per-Minute	Set Number		Pinion Gear		Driven Gear	
	Fiber	Nylon	Steel	Nylon	Fiber	Nylon
600	151100	161295	151134	159284	151135	159285
460	151075	161294	151132	159281	151133	159282
404	152766	—	152765	—	152764	—
368	151060	161293	151130	159278	151131	159279

**GENERAL OFFICES**

Teletype Corporation  
5555 Touhy Avenue  
Skokie, Illinois 60078  
PHONE: 676-1000, Skokie  
Direct Distance Dialing  
Area Code 312

**GOVERNMENT LIAISON OFFICE**

Teletype Corporation  
425—13th Street, N.W.  
Washington, D.C. 20004  
PHONE: ME 8-1016  
Direct Distance Dialing  
Area Code 202

TWX: 910-223-3611  
(24-hour automatic answering service)  
W.U. Service on premises  
TELEX: 02-5451

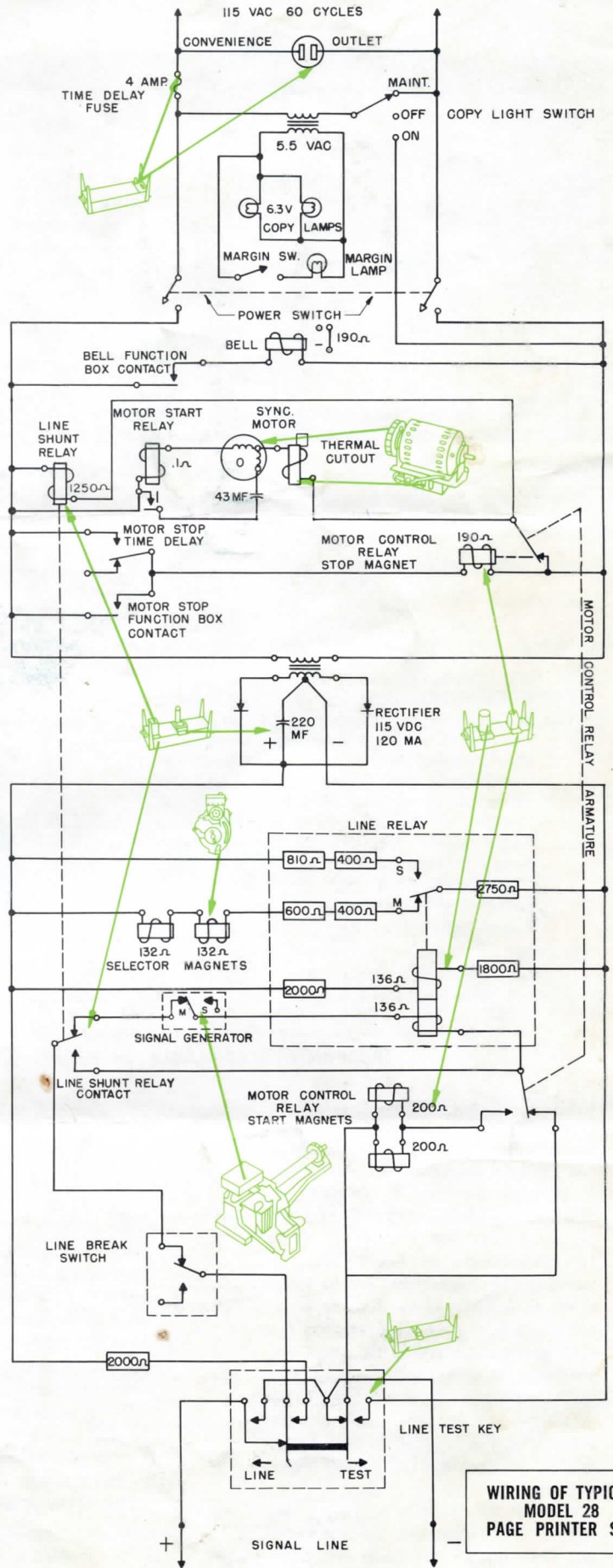

**WIRING OF TYPICAL MODEL 28 PAGE PRINTER SET**